

CASO®  
D E S I G N

# Original- Operating manual

## WineExclusive 24 Smart (718)

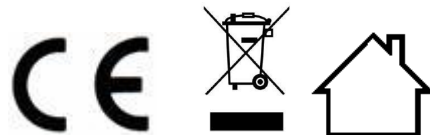

---

**Braukmann GmbH**

Raiffeisenstraße 9

D-59757 Arnsberg

Service-Hotline International:

Tel.: +49 (0) 29 32 / 80 55 4 – 99

Fax: +49 (0) 29 32 / 80 55 4 – 77

eMail: [kundenservice@caso-design.de](mailto:kundenservice@caso-design.de)

Sie finden die aktuellste Version der Bedienungsanleitung auch auf unserer  
Homepage: [www.caso-design.de](http://www.caso-design.de)

Dokument-Nr.: 00718 29-11-2021

Druck- und Satzfehler vorbehalten. Bildabweichungen zur Originalware sind technisch  
bedingt möglich.

© 2021 Braukmann GmbH

---

|           |   |           |
|-----------|---|-----------|
| <b>8</b>  | <b>Garantie</b> .....   | <b>25</b> |
| <b>9</b>  | <b>Technische Daten</b> .....   | <b>26</b> |
| <b>10</b> | <b>Operating Manual</b> .....   | <b>28</b> |
| 10.1      | General .....   | 28        |
| 10.2      | Information on this manual .....  | 28        |
| 10.3      | Warning notices .....   | 28        |
| 10.4      | Limitation of liability .....   | 29        |
| 10.5      | Copyright protection .....  | 29        |
| 10.6      | EU declaration of conformity .....  | 29        |
| <b>11</b> | <b>Safety</b> .....   | <b>29</b> |
| 11.1      | Intended use.....   | 29        |
| 11.2      | General Safety information .....  | 30        |
| 11.3      | Sources of danger .....   | 31        |
| 11.3.1    | Risk of fire / flammable materials used. Danger of burns or of explosion..... | 31        |
| 11.3.2    | Dangers due to electrical power.....  | 31        |
| <b>12</b> | <b>Commissioning</b> .....  | <b>32</b> |
| 12.1      | Safety information .....  | 32        |
| 12.2      | Delivery scope and transport inspection .....                                 | 32        |
| 12.3      | Unpacking .....   | 32        |
| 12.4      | Disposal of the packaging.....  | 33        |
| 12.5      | Setup .....   | 33        |
| 12.5.1    | Setup location requirements:.....   | 33        |
| 12.5.2    | Feet.....   | 34        |
| 12.5.3    | The handle installing .....   | 34        |
| 12.5.4    | Shelves .....   | 34        |
| 12.5.5    | To remove a shelf .....   | 34        |
| 12.6      | Electrical connection.....  | 35        |
| <b>13</b> | <b>Design and Function</b> .....  | <b>36</b> |
| 13.1      | Complete overview .....   | 36        |
| <b>14</b> | <b>Operation and Handling</b> .....   | <b>36</b> |
| 14.1      | Operating elements and displays .....   | 36        |
| 14.2      | WiFi control.....   | 37        |
| 14.3      | Rating plate .....  | 37        |
| <b>15</b> | <b>Cleaning and Maintenance</b> .....   | <b>37</b> |
| 15.1      | Safety information .....  | 37        |
| 15.2      | Cleaning .....  | 38        |
| 15.3      | Moving the appliance .....  | 38        |
| <b>16</b> | <b>Troubleshooting</b> .....  | <b>38</b> |

---

---

# 10 Operating Manual

## 10.1 General

Please read the information contained herein so that you can become familiar with your device quickly and take advantage of the full scope of its functions.

Your wine refrigerator will serve you for many years if you handle it and care for it properly.

We wish you a lot of pleasure in using it!

## 10.2 Information on this manual

These Operating Instructions are a component of the WineExclusive (referred to hereafter as the Device) and provide you with important information for the initial commissioning, safety, intended use and care of the device. The Operating Instructions must be available at all times at the device. This Operating Manual must be read and applied by every person who is instructed to work with the device:

- Commissioning
- Operation
- Troubleshooting and/or
- Cleaning

Keep the Operating Manual in a safe place and pass it on to the subsequent owner along with the device.

## 10.3 Warning notices

The following warning notices are used in the Operating Manual concerned here.

### **▲GEFAHR** DANGER

**A warning notice of this level of danger indicates a potentially dangerous situation.**

If the dangerous situation is not avoided, this can lead to death or serious injuries.

- ▶ Observe the instructions in this warning notice in order to avoid the danger of death or serious personal injuries.

### **▲WARNUNG** WARNING

**A warning notice of this level of danger indicates a possible dangerous situation.**

If the dangerous situation is not avoided, this can lead to serious injuries.

- ▶ Observe the instructions in this warning notice in order to avoid the personal injuries.

### **▲VORSICHT** ATTENTION

**A warning notice of this level of danger indicates a possible dangerous situation.**

If the dangerous situation is not avoided, this can lead to slight or moderate injuries.

- ▶ Observe the instructions in this warning notice in order to avoid the personal injuries.

### **HINWEIS** PLEASE NOTE

A notice of this kind indicates additional information, which will simplify the handling of the machine.

---

## 10.4 Limitation of liability

All the technical information, data and notices with regard to the installation, operation and care are completely up-to-date at the time of printing and are compiled to the best of our knowledge and belief, taking our past experience and findings into consideration. No claims can be derived from the information provided, the illustrations or descriptions in this manual. The manufacturer does not assume any liability for damages arising as a result of the following:

- Non-observance of the manual
- Uses for non-intended purposes
- Improper repairs
- Technical alterations, modifications of the device
- Use of unauthorized spare parts

Modifications of the device are not recommended and are not covered by the guarantee.

All translations are carried out to the best of our knowledge. We do not assume any liability for translation errors, not even if the translation was carried out by us or on our instructions. The original German text remains solely binding.

## 10.5 Copyright protection

This document is copyright protected. Braukmann GmbH reserves all the rights, including those for photomechanical reproduction, duplication and distribution using special processes (e.g. data processing, data carriers, data networks), even partially.

Subject to content and technical changes.

## 10.6 EU declaration of conformity

Hereby, Braukmann GmbH, declares that the radio equipment type [718] is in compliance with Directive 2014/53/EU. The full text of the EU declaration of conformity is available at the following internet address: <http://www.caso-design.de/nc/service/dokumente-download/>

# 11 Safety

This chapter provides you with important safety notices when handling the device. The device corresponds with the required safety regulations. Improper use can result in personal or property damages.

## 11.1 Intended use

This device is only intended for use in households in enclosed spaces for cooling wine and other beverages. Uses for a different purpose or for a purpose which exceeds this description are considered incompatible with the intended or designated use.

### **▲WARNING** WARNING

#### **Danger due to unintended use!**

Dangers can emanate from the device if it is used for an unintended use and/or a different kind of use.

- ▶ Use the device exclusively for its intended use.
- ▶ Observe the procedural methods described in this Operating Manual.

Claims of all kinds due to damages resulting from unintended uses are excluded.

The User bears the sole risk.

---

## 11.2 General Safety information

### HINWEIS

### PLEASE NOTE

**Please observe the following general safety notices with regard to the safe handling of the device.**

Examine the device for any visible external damages prior to using it. Never put a damaged device into operation.

- ▶ If the power cable or plug are damaged, then they must be replaced by the manufacturer or its service agent in order to avoid a hazard.
- ▶ This device may be used by children aged 8 and above, if they are supervised or have been instructed at to the safe use of the device and have understood the resulting hazards.
- ▶ Cleaning and maintenance by the user must not be performed by children unless they are at least 8 years old and are supervised. Children are not allowed to play with the device.
- ▶ The device and its connecting cable must be kept away from children who are less than 8 years old.
- ▶ The device may be used by individuals with reduced physical, sensory or mental capabilities or a lack of experience and / or knowledge of their use if they are supervised or have been instructed at to the safe use of the device and have understood the resulting hazards.
- ▶ Only customer service departments authorized by the manufacturer may carry out repairs on the device, as otherwise the guarantee entitlements will be null and void in the event of any subsequent damages. Improperly performed repairs can cause considerable dangers for the user.
- ▶ Defective components must always be replaced with original replacement parts. Only such parts will guarantee that the safety requirements are fulfilled.

---

## 11.3 Sources of danger

### 11.3.1 Risk of fire / flammable materials used. Danger of burns or of explosion

**▲GEFAHR** DANGER

**There is a danger of burns and explosion due to excess pressure that is created in the event the device is not used properly.**

Observe the following safety notices to avoid dangers of burns or an an explosion:



**Warning: Risk of fire / flammable materials used.**

- ▶ Do not store explosive substances such as aerosol cans with a flammable propellant in this device.
- ▶ Blowing gas inside the device is flammable.
- ▶ Do not damage the cooling circuit of the device.
- ▶ Do not use electrical devices inside the device.
- ▶ Do not use mechanical devices or other means to accelerate the defrosting process.
- ▶ Never use the device to store or dry flammable materials.
- ▶ Never clean appliance parts with flammable fluids. The fumes can create a fire hazard or explosion.
- ▶ Do not store or use gasoline or any other flammable vapours and liquids in the vicinity of this or any other appliance. The fumes can create a fire hazard or explosion.

### 11.3.2 Dangers due to electrical power

**▲GEFAHR** Danger

**Mortal danger due to electrical power!**

**Mortal danger exists when coming into contact with live wires or subassemblies!**

Observe the following safety notices to avoid dangers due to electrical power:

---

**▲GEFAHR****Danger**

- ▶ Do not operate this device if it has a damaged cable or plug, if it is not working properly or if it has been damaged or dropped. If the power cable or plug are damaged, then they must be replaced by the manufacturer or its service agent in order to avoid a hazard.
- ▶ Do not open the housing on the device under any circumstances. There is a danger of an electrical shock if live connections are touched and the electrical or mechanical structure is altered. In addition, functional faults on the device can also occur.

## 12 Commissioning

This chapter provides you with important safety notices during the initial commissioning of the device. Observe the following notices to avoid dangers and damages:

### 12.1 Safety information

**▲WARNUNG****WARNING**

- ▶ Packaging materials may not be used for playing. There is a danger of suffocation.
- ▶ Transport, unpack and use two persons to set down the device because of the heavy weight of the device.

### 12.2 Delivery scope and transport inspection

As a rule, the WineExclusive is delivered with the following components:

- WineExclusiv with WiFi equipment • 6 wooden shelves
- Operating Instructions with handle and screws

**HINWEIS****Please note**

- ▶ Examine the shipment for its completeness and for any visible damages.
- ▶ Immediately notify the carrier, the insurance and the supplier about any incomplete shipment or damages as a result of inadequate packaging or due to transportation.

### 12.3 Unpacking

To unpack the device, proceed as follows:

- Remove the device out of the carton and remove the packaging material.
- Your wine refrigerator should only be moved in an upright position.
- Clean the interior surface with lukewarm water using a soft cloth.

- 
- After at least 24 hours, plugging the appliance into the wall outlet, than place wine bottles or beverages in the appliance.

**HINWEIS****Please note**

- ▶ Only remove the blue protective film shortly before setting up the device in the location where it will be used, to prevent scratches and dirt accumulations.

## 12.4 Disposal of the packaging

The packaging protects the device against damages during transit. The packaging materials are selected in accordance with environmentally compatible and recycling-related points of view and can therefore be recycled. Returning the packaging back to the material loop saves raw materials and reduces the quantities of accumulated waste. Take any packaging materials that are no longer required to “Green Dot” recycling collection points for disposal.

**HINWEIS****Please note**

- ▶ If possible, keep the original packaging for the device for the duration of the guarantee period of the device, in order that the device can be re-packaged properly in the event of a guarantee claim.

## 12.5 Setup

### 12.5.1 Setup location requirements:

In order to ensure the safe and trouble-free operation of the device, the setup location must fulfil the following prerequisites:

- Place your appliance on a floor that is strong enough to support the appliance when it is fully loaded.
- Locate the appliance away from direct sunlight and sources of heat (stove, heater, radiator, etc.). Direct sunlight may affect the acrylic coating and heat sources may increase electrical consumption.
- This device is not designed for use in a garage or any other outside installation.
- Do not set up the device in a hot, wet or extremely damp environment or near flammable material.
- The device requires an adequate flow of air in order to operate correctly. Leave a clearance of 15 cm around the appliance.
- **WARNING!** Do not close the ventilation openings in the device housing.
- The electrical socket must be easily accessible so that the power lead can be disconnected easily, in the case of an emergency.
- The installation and assembly of this device in non-stationary setup locations (e.g. on ships) must be carried out by specialist companies / electricians, provided they guarantee the prerequisites for the safe use of this device.
- For energy saving reasons please ensure that the door is closed when the appliance is turned on.

---

### 12.5.2 Feet

There are different feet (3 bigger feet and 1 small foot). To level your appliance, adjust the small foot at the bottom of the appliance.

### 12.5.3 The handle installing

The device comes with one metal stainless steel handle. To install simply screw them to the door with the supplied screws.

To do this, slide the rubber seal on the back of the door to the side to lay open the predrilled holes. Use the included screws to install the handle on the door.

Then reinsert the rubber seal in the correct position.

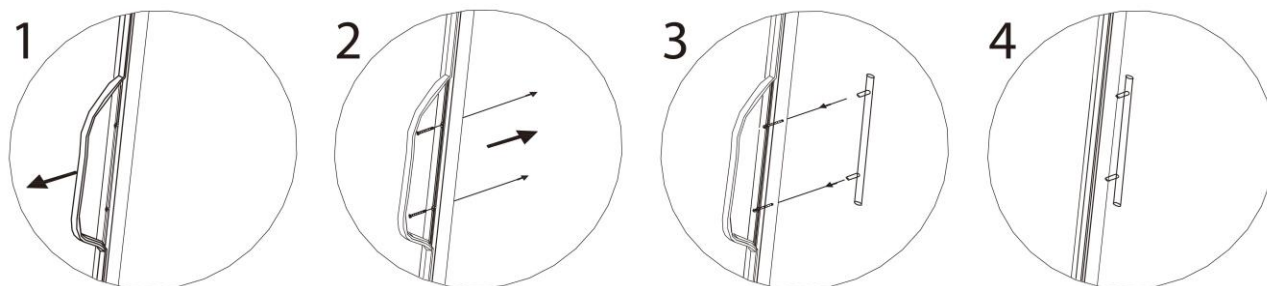

### 12.5.4 Shelves

Each shelf can be removed to store larger bottles.

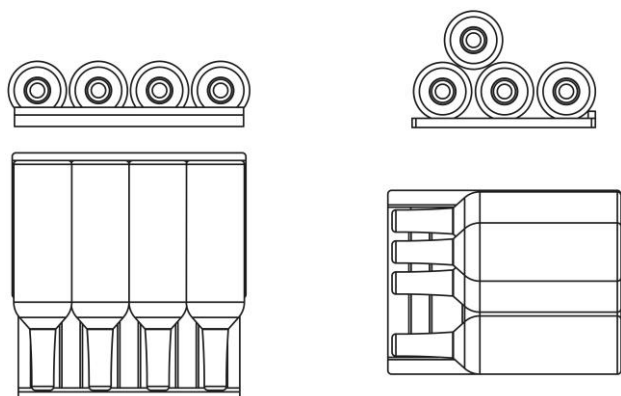

Usual shelf

Lower shelf

### 12.5.5 To remove a shelf

Remove all bottles from the shelves.

#### Removal of the fixed shelves:

Carefully pull out the shelf until this is no longer possible.

Look at the shelf rail from the side.

---

You see a lever. There are 2 positions

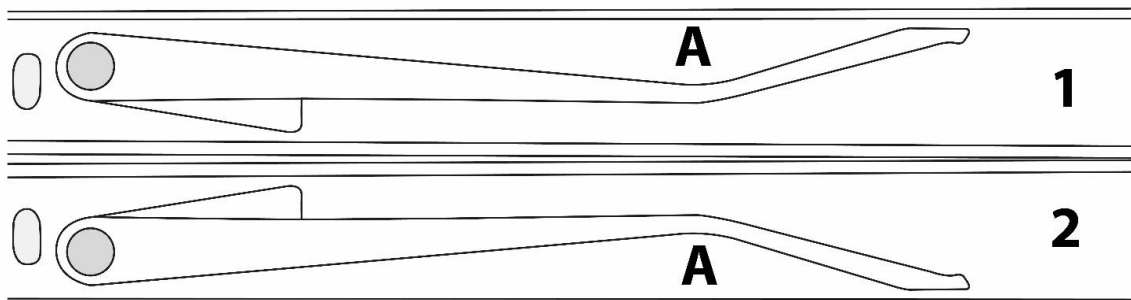

1 = below - release with pressure at point A upwards

2 = up - release with pressure at point A down

Reach into the rail with one finger and change the position of the lever by pressing the lever. Hold this new position of the lever appropriately on both sides of the shelf and then pull out the shelf.

#### Installation of the shelves:

Put the shelf back into the rail and slowly push it in until it clicks into place.

#### HINWEIS

#### Please note

- ▶ Ensure that the shelves are firmly engaged in place before storing any bottles.
- ▶ Any of the shelves can be removed to accommodate larger bottles.
- ▶ Spread your bottles out as evenly as possible over the shelves, so weight is not concentrated in one point; and make sure your bottles will not touch the back of the cabinet.

## 12.6 Electrical connection

In order to ensure the safe and trouble-free operation of the device, the following instructions must be observed for the electrical connection:

- Before connecting the device, compare the connection data (voltage and frequency) on the rating plate with those of your electrical network. This data must agree in order that no damages occur in the device. If in doubt, ask your qualified electrician.
- The connection between the device and the electrical network may employ a 3 meter long (max.) extension cable with a cross-section of 1.5 mm<sup>2</sup>. The use of multiple plugs or gangs is prohibited because of the danger of fire that is involved with this.
- Make sure that the power cable is undamaged and has not been installed under or over hot or sharp surfaces.
- This device is not designed to be installed in an RV or used with an inverter.
- The electrical outlet must be protected by a 16A safety cut-out switch.
- The electrical safety of the device is only guaranteed if the device is connected to a properly installed protective conductor system. If in doubt, have the house installation checked over by a qualified electrician.  
The manufacturer cannot be made responsible for damages that are caused by a missing or damaged protective conductor.

---

## 13 Design and Function

This chapter provides you with important safety notices on the design and function of the device.

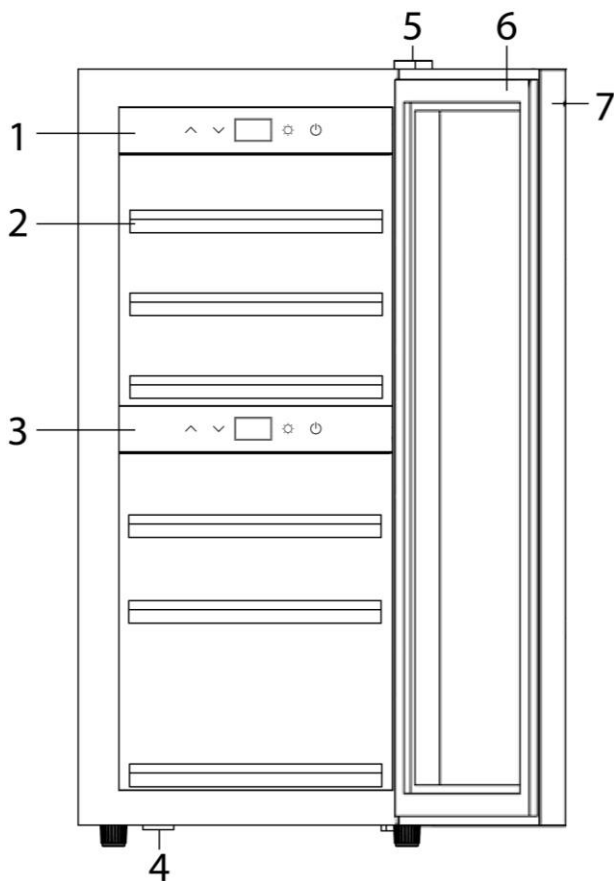

### 13.1 Complete overview

- 1 upper control panel
- 2 shelves (6 pcs)
- 3 lower control panel
- 4 locking of the door
- 5 upper hinge cover
- 6 sealing of the door
- 7 door frame (lockable)



## 14 Operation and Handling

This chapter provides you with important notices with regard to operating the device.

### 14.1 Operating elements and displays



#### HINWEIS

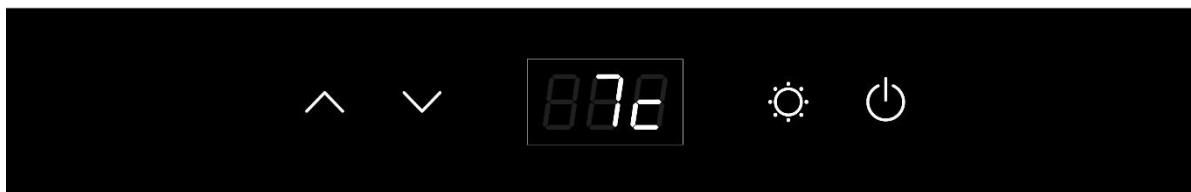

#### Please note

- ▶ Use the buttons  and  to set the temperature for both zones in the range of 5-20°C.
- ▶ Temperature recommendations: Red wine: 12°C – 16°C and white wine 6°C – 10°C.
- ▶ The device can achieve the best cooling and consumption results at a recommended ambient temperature of 16-20 °C.
- ▶ When both - up and down zone - are working, the temperature of upper zone must be lower than or equal to the temperature of down zone.
- ▶ In case of high temperature difference between both zones the energy consumption of the device may be higher as indicated in the technical data.



If you press the power button of : Upper zone -> the device is switched on  
Down zone -> the down zone is switched on/off

When the LED lights the device is working. With pushing both  and  for 5 seconds, the temperature display mode will be exchange between °C and °F.

You can set the temperature as your desire: With  and  you can adjust the temperature in 1°C steps from 5-20°C.



You can switch the interior light on or off by pressing the “Light” button. The light will switch off automatically after 4 hours to save energy. The temperature in the device depends on the room temperature, the quantity of bottles and the chosen temperature. Please note that your device is intended to cool wine. The maximum temperature that can be reached inside the device cannot be significantly ABOVE the ambient temperature at the setup location.

## 14.2 WiFi control

The device can optionally also be controlled / programmed via app via WiFi. Download the CASO-App to your smartphone or tablet. Details about the app, the scope of operation and installation instructions can be found on our website [www.casoapp.com/help](http://www.casoapp.com/help)

## 14.3 Rating plate

The rating plate with the connection and performance data can be founded on the back of the device.

# 15 Cleaning and Maintenance

This chapter provides you with important notices with regard to cleaning and maintaining the device. Please observe the notices to prevent damages due to cleaning the device incorrectly and to ensure trouble-free operation.

## 15.1 Safety information

### **▲VORSICHT** Attention

Please observe the following safety notices, before you commence with cleaning the device:

- ▶ Prior to commissioning, clean the appliance thoroughly.
- ▶ Switch the device off prior to cleaning it and unplug the plug from the wall power outlet. Remove all content.
- ▶ Do not use any aggressive or abrasive cleaning agents or solvents.
- ▶ Do not scrape off stubborn dirt with hard items.

---

## 15.2 Cleaning

### ◆ Interior space

Wash the inside with a damp cloth soaked in lukewarm water and a bit of mild detergent.

Tip for neutralisation of odors: Wash the inside with a damp cloth soaked in lukewarm water and baking soda solution. The solution should be about 2 tablespoons of baking soda to a quarter of water. After cleaning the interior space, leave the oven door open until the interior of the device is completely dry.

### ◆ Door gasket

Be sure to keep the door gasket clean to keep the unit running efficiently.

### ◆ Cabinet

The cabinet should be cleaned with a mild detergent and warm water.

Use a soft, damp cloth for drying.

### ◆ Vent opening

Dust or anything else may block the vent and hinder the cooling efficiency of the appliance. Vacuum the vent if necessary.

### ◆ Container for condensed water (K)

Remove regularly the condensed water with a sponge from the container for condensed water. The container is located on the back side of the device at the right bottom.



### ◆ Manual defrosting

Please defrost the device at least every 6 months. When you open the door of the device frequently, you need to perform the defrosting more often.

Turn off the power but do not unplug the power plug. Let the appliance then defrost manually. Pay attention to the container for condensed water(K) and remove the condensed water during the defrosting.

## 15.3 Moving the appliance

Turn off the appliance first and then unplug the unit from the wall outlet.

Remove all content. Shurely tape down all lose items inside your appliance.

Tape doors shut. Be sure the wine refrigerator stays in the upright position during transportation.

## 16 Troubleshooting

This chapter provides you with important notices with regard to operating the device. Observe the following notices to avoid dangers and damages:

---

## 16.1 Safety notices

### **▲VORSICHT** Attention

- ▶ Only qualified electricians, who have been trained by the manufacturer, may carry out any repairs on electrical equipment.
- ▶ Improperly performed repairs can cause considerable dangers for the user and damages to the device.

## 16.2 Fault indications and rectification of faults

The following table assists in localizing and rectifying minor faults.

| Fault   | Possible Cause  |
|---|---|
| Your device is not cold enough or it does not reach the adjusted temperature:         | Check the temperature control setting.<br>External environment may require a higher setting.<br>The door is open too often.<br>The door is not closed completely.<br>The door seal does not seal properly.<br>Defrost the device. |
| The light does not work.  | Contact customer service.   |
| Vibrations & too much noise & door does not close properly                            | Check to assure that the wine refrigerator is level. Check the fan. Components are loose. Device touches the wall.<br>The door is reversed and not properly installed.<br>The seal is weak. The shelves are out of position.      |
| LED could not display.<br>LED display error – <b>Lo</b><br>Buttons are not functional | Contact customer service.   |
| Compressor will not start   | Room temperature is lower than desired temperature.   |
| Dew on the surface of cabinet   | The surface of wine cabinet especially the glass door appear some frost if item in a damp room.<br>This is due to the moisture in the air coming into contact with the cabinet. Please wipe it away with dry cloth.               |
| Liquid sound  | 1) The sound of compressor when starts or stops working<br>2) The flowing sound of refrigerant in the refrigeration system<br>3) The evaporating sound of refrigerant in the evaporator   |
| Condensation formed inside the cabinet  | Under the environment with high level of humidity or the door of wine cabinet has been left open for a long period or opened frequently, wipe off the door and walls. Open the door as rarely as possible.                        |

|                |   |
|----------------|---|
| Error code E2  | Desired temperature is not reached.<br>If necessary defrost the device (Please follow the hints for manual defrosting in chapter cleaning). |
| Error code CE1 | WiFi connection established, but no connection to the internet  |
| Error code CE2 | DNS Error – Route to Cloud not found  |
| Error code CE3 | CASO Cloud Server not reachable   |
| Error code CE4 | WiFi not found, possible reason signal too weak   |
| Error code CE5 | Update Server not reachable   |

### HINWEIS

### Please note

- ▶ If you are unable to solve the problem with the steps shown above, please contact Customer Service.

## 17 Disposal of the Old Device

Old electric and electronic devices frequently still contain valuable materials. However, they also contain damaging substances, which were necessary for their functionality and safety. If these were put in the non-recyclable waste or were handled incorrectly, they could be detrimental to human health and the environment. Therefore, do not put your old device into the non-recyclable waste under any circumstances.



### HINWEIS

### Please note

- ▶ Utilise the collection point, established in your town, to return and recycle old electric and electronic devices. If necessary, contact your town hall, local refuse collection service or your dealer for information.
- ▶ Ensure that your old device is stored safely away from children until it is taken away: Before you throw away your old refrigerator take off the doors and leave the shelves in place, so that children may not easily climb inside.
- ▶ Blowing gas inside the unit is flammable. The disposal of this flammable material should be in accordance with national regulations.

## 18 Guarantee

We provide a 24 month guarantee for this product, commencing from the date of sale, for faults which are attributable to production or material faults.

Your legal guarantee entitlements in accordance with § 439 ff. BGB-E remain unaffected by this. The guarantee does not include damages, which were incurred as a result of improper handling or use, as well as malfunctions which only have a minor effect on the function or the value of the device.

---

Consumables, transit damages, inasmuch as we are not responsible for these, as well as damages, which were incurred as a result of any repairs that were not performed by us, are also excluded from the guarantee entitlements. This device is designed for use in domestic situations and has the appropriate performance levels.

Any use in commercial situations is only covered under the guarantee to the extent that it would be comparable with the stresses of being used in a domestic situation. It is not intended for any additional, commercial use.

In the event of justified complaints, we will repair the faulty device at our discretion or replace it with a trouble-free device.

Any pending faults must be reported within 14 days of delivery.

All further claims are excluded.

To enforce a guarantee claim, please contact us prior to returning the device (always provide us with proof of purchase).

## 19 Technical Data

|   |                               |
|---|-------------------------------|
| <b>Name</b>   | <b>WineExclusive 24 Smart</b> |
| <b>Article No.</b>  | 718                           |
| <b>Power</b>  | 60W                           |
| <b>Average daily energy consumption</b>                       | 0.372kW.h/24h                 |
| <b>Daily energy consumption at 16 ° C ambient temperature</b> | 0.128kW.h/24h                 |
| <b>Daily energy consumption at 32 ° C ambient temperature</b> | 0.616kW.h/24h                 |
| <b>Connection</b>   | 220 - 240 V; 50 Hz            |
| <b>Outside dimensions (W/HD)</b>                              | 400 x 875 x 585 mm            |
| <b>Bottles</b>  | 24 bottles                    |
| <b>Weight:</b>  | 37 kg                         |
| <b>WLAN / WIFI</b>  | IEEE 802.11 b/g/n             |
| <b>Frequency band</b>   | 2.4 - 2.4835 GHz              |
| <b>Climate class</b>  | ST                            |



## Quick guide

# Pairing procedure for Android



---

The following quick guide explains how to connect your CASO product to the CASO app, allowing you to use it to control the product.

To set up the connection you will require a stable Wi-Fi network which should not be switched off after set-up as this will break the connection to the CASO product.

1. Before you begin, download the CASO app from the app store and set up a CASO account.

2. Switch on your CASO product fully.



3. Open the CASO app and press the “Add device” button

4. Press the pairing button combination on your CASO product, as shown in the CASO app.

- Press the Power and Light buttons simultaneously until the CASO product beeps.



5. Let go of the buttons as soon as you hear the beeping sound.

- After approx. 5-10 seconds a four-digit code (pairing code) will appear in the display (consecutively / simultaneously in both displays). This code will be displayed for 3 minutes.



*(Example)*

- You can remove the pairing code from the display at any time by pressing the “Light” button.



6. Click “Continue” in the CASO app.

- After that, the search for new CASO products will start.
- If no new CASO product is found, the notification “No new devices found” will appear. Please confirm by clicking “OK” and repeat the steps described in this quick guide, starting with Step 3.

7. Following this, select a new CASO product in the CASO app.

- You will be asked to enter the pairing code (4-digit code shown on the device’s display).

- 
- Please note that this code is a hexadecimal code; only the following characters may be used:  
0 - 9 and a - f (not case-sensitive).

8. Select your Wi-Fi network

- Network name (SSID)
- Password (pre-shared key)

**Important:** Please note that connections can only be made to 2.4 GHz (802.11n) networks.

9. Following transmission of the Wi-Fi data to the CASO product, your CASO product will be assigned to your account. The outcome will be stored in the CASO cloud so that your data cannot be lost, even after a re-installation. This process may take up to 2 minutes.

10. The CASO product will automatically re-start itself when this process has been completed.

Note:

The time it takes for the current device data to be displayed in the CASO app can vary depending on the quality of the connection.



## Quick guide

# Pairing procedure for iOS



---

The following quick guide explains how to connect your CASO product to the CASO app, allowing you to use it to control the product.

To set up the connection you will require a stable Wi-Fi network which should not be switched off after set-up as this will break the connection to the CASO product.

1. Before you begin, download the CASO app from the app store and set up a CASO account.

2. Switch on your CASO product fully.



3. Open the CASO app and press the “Add device” button

4. Press the pairing button combination on your CASO product, as shown in the CASO app.

- Press the Power and Light buttons simultaneously until the CASO product beeps.



5. Let go of the buttons as soon as you hear the beeping sound.

- After approx. 5-10 seconds a four-digit code (pairing code) will appear in the display (consecutively / simultaneously in both displays). This code will be displayed for 3 minutes.



- You can remove the pairing code from the display at any time by pressing the “Light” button.



6. Click “Continue” in the CASO app.

- You will be asked to select the CASO product in your mobile device’s Wi-Fi settings.

The name of the CASO product is made up of the word “CASO” and an 11-figure letter/number combination.

**Example: CASO-1234abcd567**

- If no new CASO product is found, the notification “No new devices found” will appear. Please confirm by clicking “OK” and repeat the steps described in this quick guide, starting with Step 3.

- 
7. Following this, select a new CASO product in the CASO app.
    - You will be asked to enter the pairing code (4-digit code shown on the device's display).
    - Please note that this code is a hexadecimal code; only the following characters may be used:  
0 - 9 and a - f (not case-sensitive).
  8. Select your Wi-Fi network
    - Network name (SSID)
    - Password (pre-shared key)

**Important:** Please note that connections can only be made to 2.4 GHz (802.11n) networks.
  9. Following transmission of the Wi-Fi data to the CASO product, your CASO product will be assigned to your account. The outcome will be stored in the CASO cloud so that your data cannot be lost, even after a re-installation. This process may take up to 2 minutes.
  10. The CASO product will automatically re-start itself when this process has been completed.

**Note:**

The time it takes for the current device data to be displayed in the CASO app can vary depending on the quality of the connection.

---

**Braukmann GmbH**

Raiffeisenstrasse 9

D-59757 Arnsberg

International Service Hotline:

Tel.: +49 (0) 29 32 / 80 55 4 – 99

Fax: +49 (0) 29 32 / 80 55 4 – 77

[eMail: kundenservice@caso-germany.de](mailto:kundenservice@caso-germany.de)

Internet: [www.caso-germany.de](http://www.caso-germany.de)

Document No.: 12-2018-01

Printing and typesetting errors excepted.

© 2017 Braukmann GmbH