

*

*

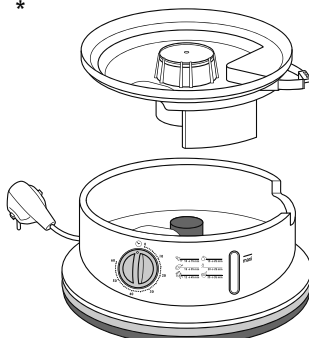

*selon modèle- depending on model - Je nach Modell - Afhankelijk van het model - A seconda del modello
 - Según modelo - depending do modelo - в зависимости от модели - залежно від моделі
 w zależności od modelu - v závislosti na modelu - modelltöl függően - v závislosti na modeli

1

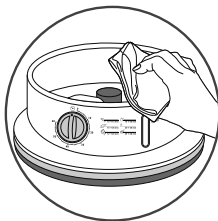
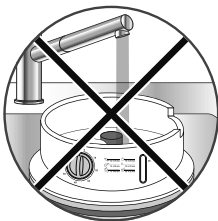
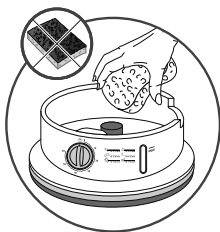
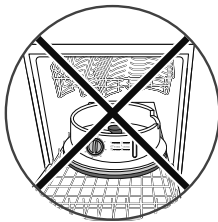
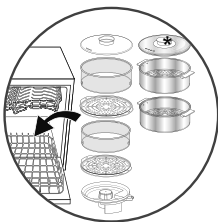
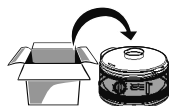

2a

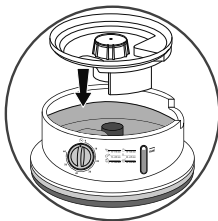
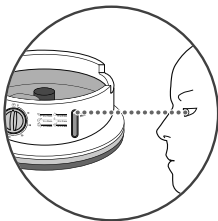
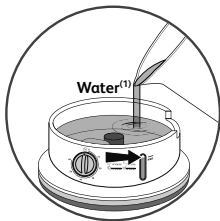

*selon modèle- depending on model - Je nach Modell - Afhankelijk van het model - A seconda del modello - Según modelo - dependendo do modelo - в зависимости от модели - залежно від моделі w zależności od modelu - v závislosti na modelu - modelltól függően - v závislosti na modeli

⁽¹⁾water - Eau - Wasser - acqua - aqua - água - вода - voda - voda- viz

2b _____

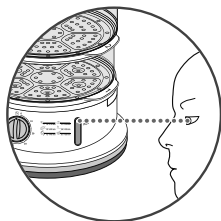
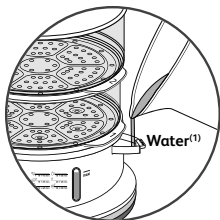
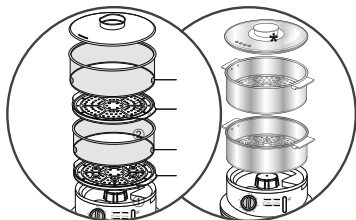
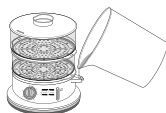

3a _____

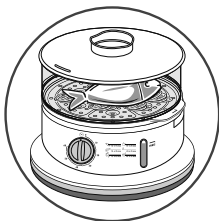
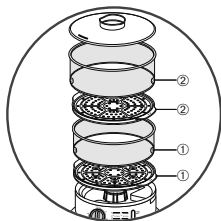

4

*selon modèle- depending on model - Je nach Modell - Afhankelijk van het model - A seconda del modello - egún modelo - dependendo do modelo - в зависимости от модели - залежно від моделі
w zależności od modelu - v závislosti na modelu - modelltől függően - v závislosti na modeli

⁽¹⁾water - Eau - Wasser - acqua - aqua - água - вода - woda - voda - víz

3a _____

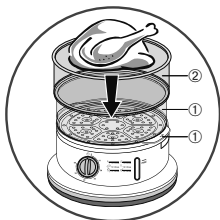

3b _____

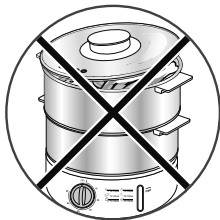
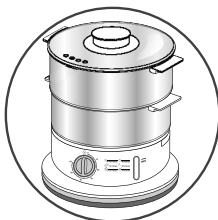
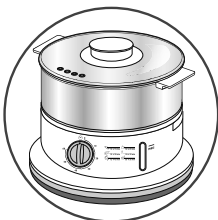
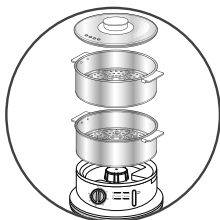
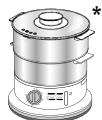

*selon modèle- depending on model - Je nach Modell - Afhankelijk van het model - A seconda del modello - Según modelo - dependendo do modelo - в зависимости от модели - залежно від моделі w zależności od modelu - v závislosti na modelu - modelltól függően - v závislosti na modeli

4

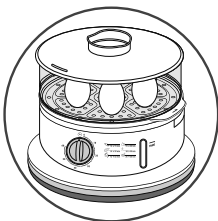
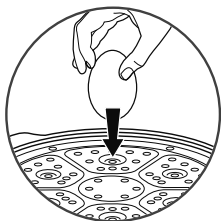
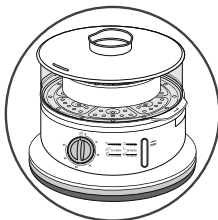
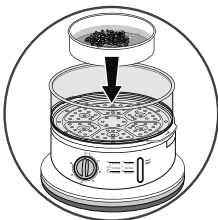
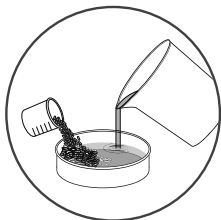

5

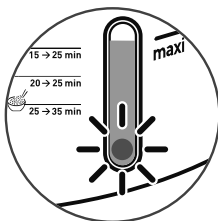
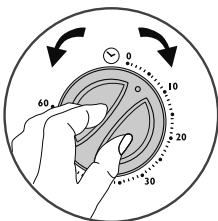
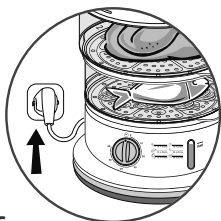

6

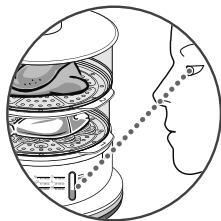
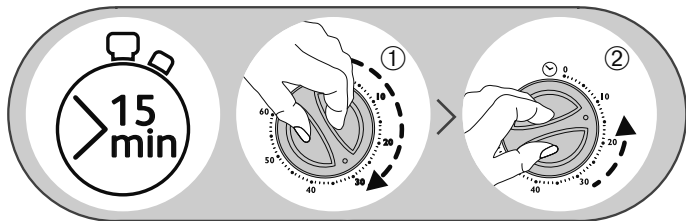

⁽¹⁾water - Eau - Wasser - acqua - agua - água - вода - voda - voda - víz

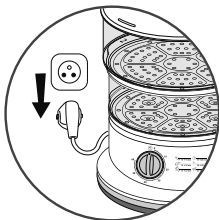
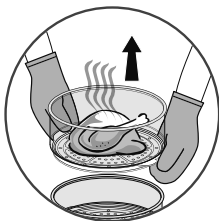
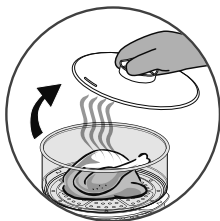
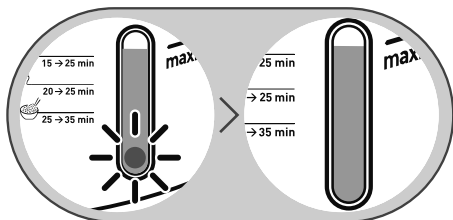
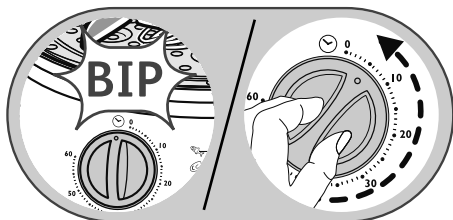

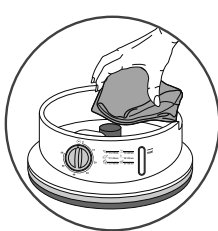
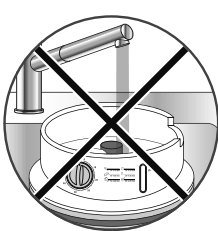
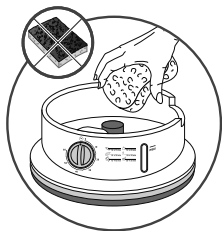
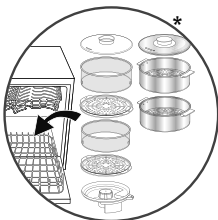
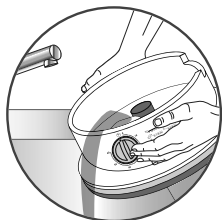
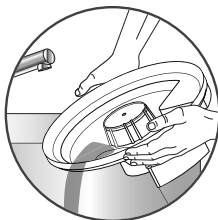
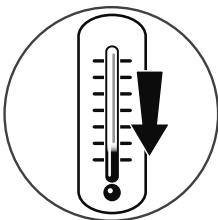
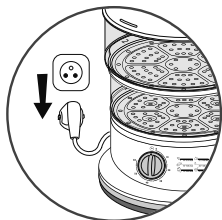

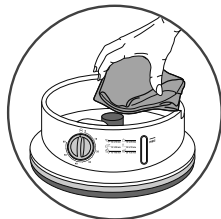
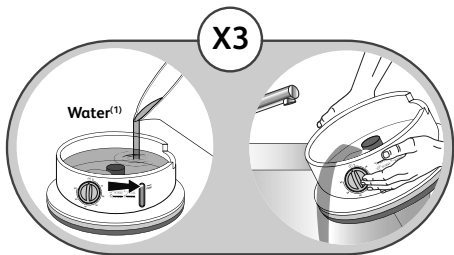
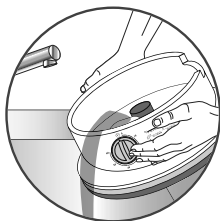
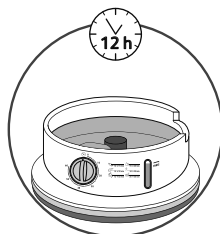
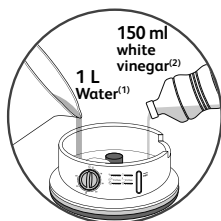
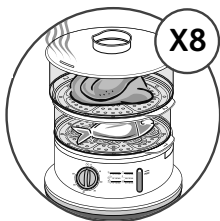





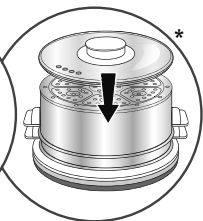
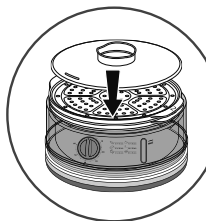
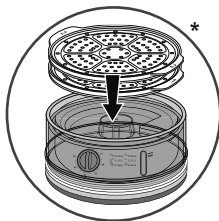
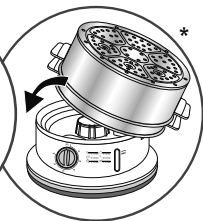
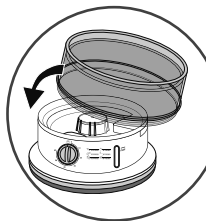
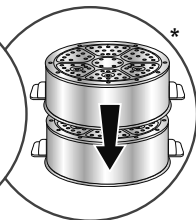
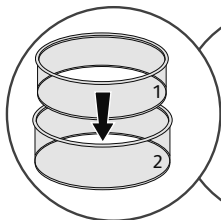
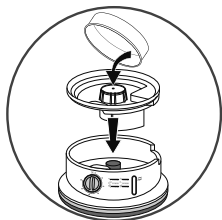
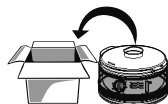

















































⁽¹⁾water - Eau - Wasser - acqua - agua - água - вода - woda - voda - viz

⁽²⁾white vinegar - vinaigre blanc - Essig - witte azijn - vinagre blanco - aceto bianco - vinagre branco - білий оцет - белый уксус - biały ocet - ocet - fehér ecet - ocot





			 (i) 
		550 g	30-35 min
		500 g	30-35 min
 ***		400 g	25-31 min
		300 g	20-25 min
		500 g	20-25 min
		600 g	25-30 min
			30-35 min
		300 g	15-20 min
 ***		300 g	15-20 min
		450 g	35-40 min
 ***		400 g	30-35 min

			300 g	  (i) 
			300 g	 
			600 g	 
			600 g	 
			4	  (i) 
			4	 
			350 g	  (i) 
			400 g	 
			300 g	 
			450 g	 
			4	 
			6	 
			125 g	 

⁽ⁱ⁾water - Eau - Wasser - acqua - agua - água - вода - voda - voda - víz

