

TEFAL

PREP'MIX+

(HT460138; HT462138)

Käsimikser  
Kasutusjuhend

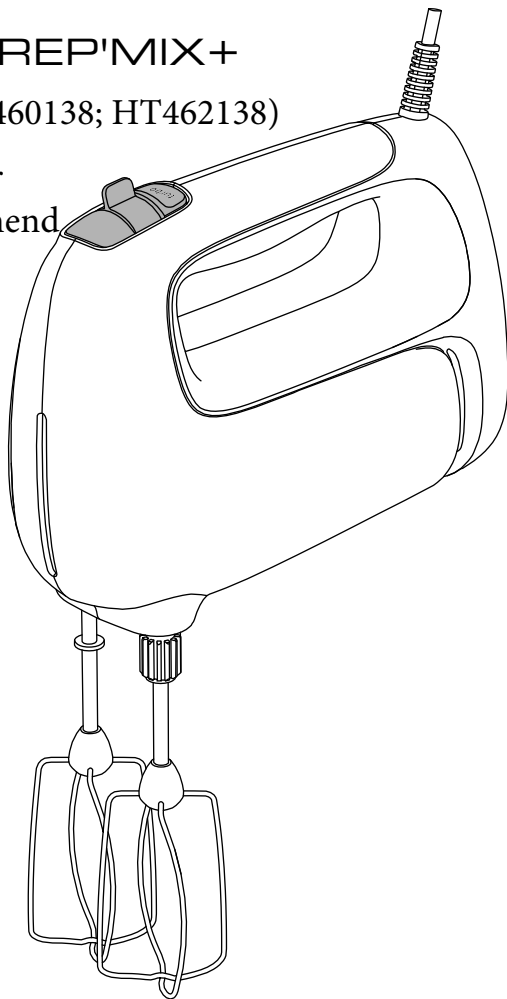

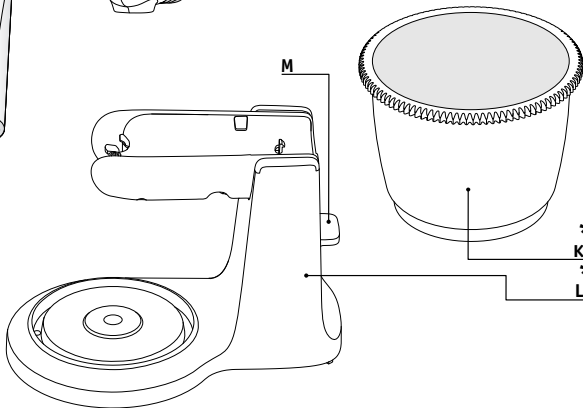
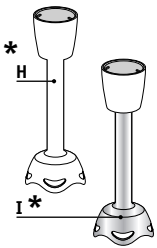
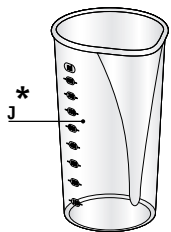
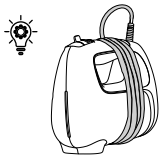
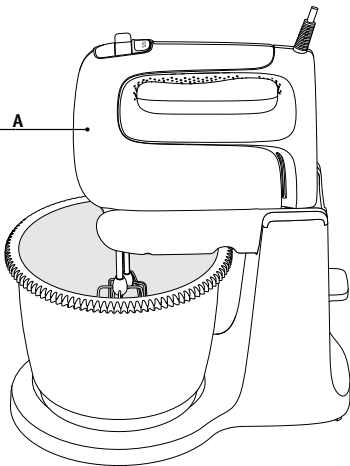
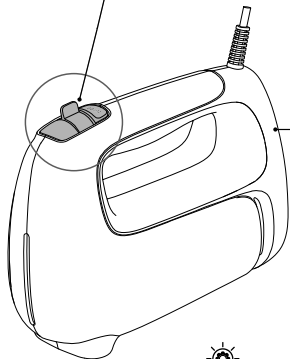
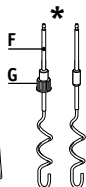
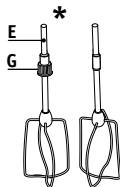
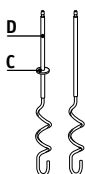
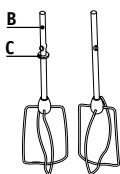
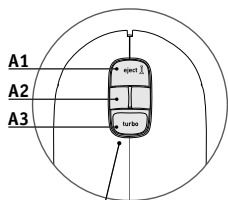

1

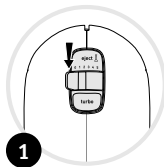

1

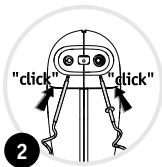

2

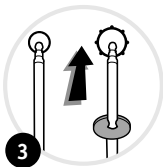

3

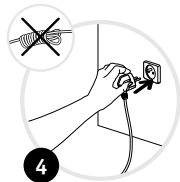

4



5

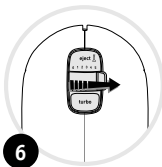

6

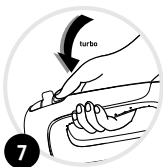

7

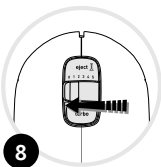

8

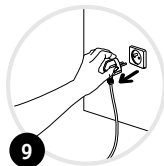

9



10

2

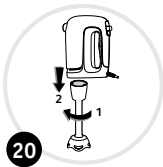
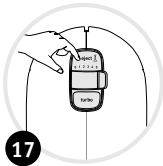
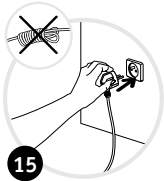
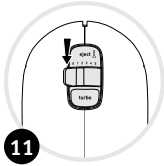

3



\*



4



\*

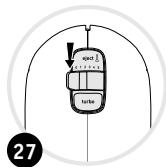

27

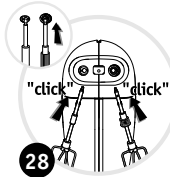

28



29



30



31

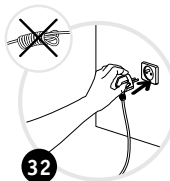

32



33

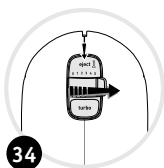

34



35

Turbo

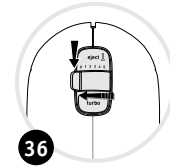

36



37

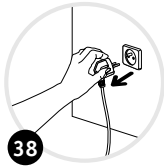

38



39

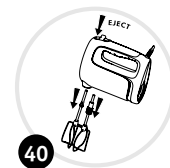

40



6



	Max.			
	30% fat mini.	500 ml	3 min. & 2 min.	3 & 5
		50 g		
		x 2	2 min.	2
		x 1 (15 g)		
		200 ml		
 175°C 60 min.	T55	200 g	30 s. & 120 s.	3 & 5
		x 4		
		200 g		
		200 g		
		5 g		
		x 6	120 s.	5





	Max.			
	T55	200 gr	40s	Eject
		x 3 (165 g)		
		4 g		
		400 g (40 cl)		
MINI CHOPPER		40g	3 s.	Eject
		x 1	30 s.	Eject
		x 1 (15 g)		
		250 ml		
	350 ml		40 s.	Eject
		100 g	40 s.	Eject
		100 g		
		100 g		
		50 ml		



	Max.			
<p>Zzzzz 40°C 120 min. 220°C 40 min.</p>	T55	600 g	10 min.	5
		400 ml		
		10 g		
		10 g		
<p>Zzzzz 40°C 180 min. 180°C 35 min.</p>	T55	380 g	6 min.	5
		50 g		
		6 g		
		x 4 (220 g)		
		5 g		
		180 g	8 min.	5
<p>Zzzzz 40°C 90 min. 220°C 35 min.</p>	T110	500 g	10 min.	5
		x 2 (10 g)		
		320 ml		
		10 g		
		30 g		
	T55	400 g	5 min. & 3 min.	5 & 2
		180 g		
		70 g		
		5 g		
		x 2		

**Hea klient! Aitäh, et valisite meie käsimikseri Prep/Mix+! Siit leiate kogu vajaliku teabe selle kasutamise kohta. Loodame, et naudite mikseri kasutamist!**

N.B.: Seadmega tarnitakse ohutusjuhiseid sisaldav brošüür.

Enne seadme esmakordset kasutamist lugege brošüüri hoolikalt ja hoidke see tuleviku tarbeks alles.

**Enne kasutamist eemaldage kõik tarvikud pakendist ja puhastage need kuuma vee ning vähesese pesuveelikuga, välja arvatud mootoriplakk (A). Loputage korralikult ja kuivatage hästi.**

## ESMAKORDNE KASUTAMINE

### KÄSIMIKSERI KASUTAMINE

- Proverite da li je prekidač za izbor brzine (A2) postavljen na „0“.
- Gurnite štapove mutilica (B) ili metlica za mešenje (D) u odgovarajuće otvore tako da ulegnu u ležište. **Mutilice i metlice za mešenje imaju prepoznatljiv oblik, tako da mutilicu ili metlicu za mešenje sa oznakom mutilice (C) treba postaviti sa desne strane, u najveći otvor (sl. 2).**
- Priklučivanje aparata:
  - Aparat ima pet brzina i turbo dugme. Uvek počnite sa mučenjem ili mešenjem sa postavkom brzine 1, a zatim pređite na postavku 2, 3, 4 ili 5.
- Kada završite, podesite prekidač za izbor brzine (A2) na „0“.
- **Isključite aparat.**
- Zatim pritisnite dugme za izbacivanje (A1) kako biste uklonili mutilice ili metlice za mešenje.

## ALUSE (L) KASUTAMINE (VASTAVALT MUDELILE)

- Asetage alus töölauale
- Õla tõstmiseks vabastage see nuppu (M) vajutades
- Asetage kauss (K) kohale
- Hoova vabastamiseks ja selle langetamiseks vajutage nuppu (M)
- Asetage tainakonsude (F) või vahustusvisplitega (E) mikser (A) hingedega õla külge, kuni kuulete, et see oma kohale klõpsab. Visplitel ja tainakonsudel on kindel kuju, tainakonsk või vispli märgiga (G) vispel tuleb paigutada paremale, suurimasse avasse.
- Ühendage seade vastavalt eespool toodud juhistele
- Kui olete lõpetanud, seadistage kiiruse juhik (A2) olekule „0“.
- Lahutage ja vajutage liigendiga õla tõstmiseks nuppu (M). Mikseri aluselt eemaldamiseks vajutage mikseri vabastusnuppu.
- Seejärel vajutage visplite või konsude eemaldamiseks väljutusnuppu (A1).

## KÄSIMIKSERI JALA (H VÕI I) KASUTAMINE (VASTAVALT MUDELILE)

Veenduge, et kiiruse juhik (A2) on olekus „0“.

- Eemaldage seadme (A) tagaosa paneel ja keerake käsimikseri jalga (H või I) paremale pöörates (ärge kasutage jõudu), kuni kuulete väikest klõpsu. Sau on õigesti paigaldatud. (Joonised 12 ja 13).
- Ühendage seade:
  - pritsimise vältimiseks kastke segamisau enne alustamist ettevalmistatava toidu sisse;
  - hakake kasutama väljutusnuppu EJECT;
  - peatage seade enne, kui eemaldate selle mikserisaua küljest (pritsmete vältimiseks).

**Kui tunnete saua kinnitamisel takistust, siis pole see õigesti joondatud. Peate selle täielikult eemaldama ja siis selle uuesti õigesti kinni keerama.**

- Valige seade „0”, lahutage seade vooluvõrgust ja eemaldage mikseri sau (N) seda vastupäeva keerates. (Joonis 20)

### HOIUSTAMINE

Ärge hoiustage seadet niiskes keskkonnas.

### MIDA TEHA, KUI TEIE SEADE EI TÖÖTA?

Kontrollige järgmist:

see on õigesti vooluvõrku ühendatud;

tarvikud on nõuetekohaselt ühendatud;

kiiruse juhiku (A2) asendit: lülitage see asendile „0” ja seejärel taas soovitud kiirusele.

Seade ei tööta ikka? Pöörduge kinnitatud teeninduskeskuse poole (vt loendit brošüüri viimasel lehel).

### KASUTUSELT KÕRVALDATUD ELEKTRI- VÕI ELEKTRONIKATOOTED



Pakend koosneb eranditult materjalidest, mis ei ohusta keskkonda ja mille võib seetõttu kõrvaldada vastavalt teie piirkonnas kehtivatele ringlussevõtmise meetmetele. Seadme kõrvaldamise kohta küsige teavet kohaliku omavalitsuse vastavast osakonnast.

#### Mõelge esmalt keskkonnale!

- ① Teie seade sisaldab väärtuslikke materjale, mida saab taaskasutada või ümber töödelda.
- ➡ Viige see kohalikku jäätmekäitluskeskusesse.